

DIXIT RA11 RECESSED

A56020-

base number _____ Color _____
 Temperature _____

- To build a product code in our configurator select the specify button on the base model # product page
- To build a manual product code on this datasheet choose from the options listed below in blue font and add the suffix to the base model #

GENERAL

Series: Dixit
 Subseries: Dixit RA11
 Brand: Ivela
 Division: Architectural
 Mounting Type: Recessed
 Mounting Location: Ceiling
 Subcategory: Downlight

PHYSICAL

Shape: Round
 Diameter (mm): 110
 Diameter (in): 4 ⁵/₁₆
 Height (mm): 70
 Height (in): 2 ⁷/₁₆
 Min. Recessing Depth (mm): 110
 Min. Recessing Depth (in): 4 ¹⁵/₁₆
 Light Distribution: Direct
 Weight (kg): 0.6
 Weight (lbs): 1.32
 Diffuser: Clear Polycarbonate
 Fixture Finish: MWH
 Fixture Material: Aluminum Die Cast
 Cut-out Measurements: 100mm / 3 15/16"

ELECTRICAL

Lamp Type: LED
 Total Output Wattage (W): 12 / 18 / 26
 Dimming: Tri-Mode (Non-Dimming and Phase Dimming (120Vac only) and 0-10V Dimming)
 Driver Included: No
 Driver Location: Recessed Housing
 Driver Type: Constant Current - Universal
 Driver Class: Class 2
 Input Voltage (V): 120 - 277
 Constant Current (MA): 350 / 500 / 700

LED

Number of LEDs: 1
 Color Temperature (°K): 2700 / 3000 / 4000
 Max. Delivered Lumen (lm): 1513 / 2092 / 2759
 CRI: >85 CRI
 Efficiency (%): 89
 Lamp Life (hrs): 50000
 Upon Request: 3500K upon request

OPTICAL

Optic°: 55
 Adjustability: Fixed
 Upon Request: Optic 18° or 30° (mirror-metallized) / 70° (white)

RATINGS AND CERTIFICATIONS

Certified By: Certified for North American Standards
 IP rating: IP43
 IK Rating: IK08
 Glare Rating: ≤ 19

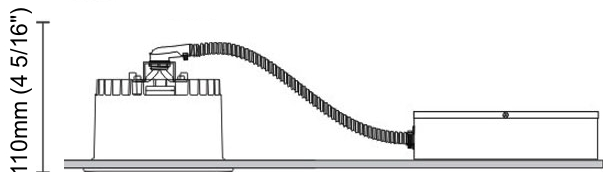

DIXIT RA11 RECESSED

A56020-

| | |
|-----------|--|
| PROJECT | |
| TYPE | |
| SPECIFIER | |
| QUANTITY | |
| DATE | |

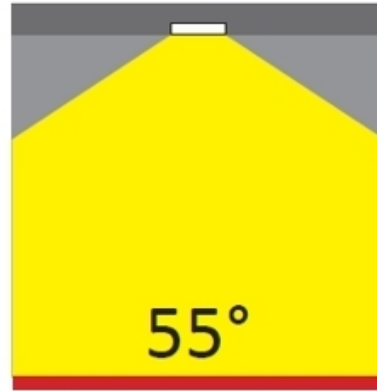
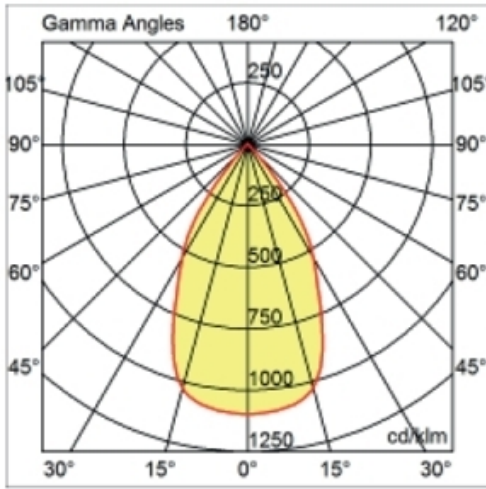

| RA 11 DIXIT LED 12W 1700LM 3000K | | | | R:100% | | I.Max:1096 Cd/Klm | | | | |
|----------------------------------|------|---------|---------|-----------|------|-------------------|------|---------|---------|----------|
| H[m] | D[m] | Max lux | Med lux | Alpha=55° | | H[m] | D[m] | Max lux | Med lux | Beta=55° |
| 1.00 | 1.13 | 1658 | 898 | | | 1.00 | 1.13 | 1658 | 898 | |
| 2.00 | 2.26 | 415 | 224 | | 2.00 | 2.26 | 415 | 224 | | |
| 3.00 | 3.38 | 184 | 100 | | 3.00 | 3.38 | 184 | 100 | | |
| 4.00 | 4.51 | 104 | 56 | | 4.00 | 4.51 | 104 | 56 | | |
| 5.00 | 5.64 | 66 | 36 | | 5.00 | 5.64 | 66 | 36 | | |

| | | | |
|-------------------|-----------------|-------------------------|----|
| | DP | DV | |
| Dimming | Phase | 0-10V | |
| Color Temperature | 27K 30K 35K 40K | 2700K 3000K 3500K 4000K | K° |

Order Example **L5XXXXXX-DV-30K**

0-10V 3000K



DIXIT RA11 RECESSED

A56028-

base number Color
Temperature

- To build a product code in our configurator select the specify button on the base model # product page
- To build a manual product code on this datasheet choose from the options listed below in blue font and add the suffix to the base model #

GENERAL

Series: Dixit
 Subseries: Dixit RA11
 Brand: Ivela
 Division: Architectural
 Mounting Type: Recessed
 Mounting Location: Ceiling
 Subcategory: Downlight

PHYSICAL

Shape: Round
 Diameter (mm): 126
 Diameter (in): 4 ¹⁵/₁₆
 Height (mm): 104
 Height (in): 4 ¹/₈
 Min. Recessing Depth (mm): 144
 Min. Recessing Depth (in): 5 ¹¹/₁₆
 Light Distribution: Direct
 Weight (kg): 0.6
 Weight (lbs): 1.32
 Diffuser: Clear Polycarbonate
 Fixture Finish: MWH
 Fixture Material: Aluminum Die Cast
 Cut-out Measurements: 122mm / 4 13/16"

ELECTRICAL

Lamp Type: LED
 Total Output Wattage (W): 12 / 18 / 26
 Dimming: Tri-Mode (Non-Dimming and Phase Dimming (120Vac only) and 0-10V Dimming)
 Driver Included: No
 Driver Location: Recessed Housing
 Driver Type: Constant Current - Universal
 Driver Class: Class 2
 Input Voltage (V): 120 - 277
 Constant Current (MA): 350 / 500 / 700

LED

Number of LEDs: 1
 Color Temperature (°K): 2700 / 3000 / 4000
 Max. Delivered Lumen (lm): 1513 - 1602 / 2092 - 2180 / 2759 - 2848
 CRI: >85 CRI
 Efficiency (%): 89
 Lamp Life (hrs): 50000
 Upon Request: 3500K upon request

OPTICAL

Optic°: 55
 Adjustability: Fixed
 Upon Request: Optic 18° or 30° (mirror-metallized) / 70° (white)

RATINGS AND CERTIFICATIONS

Certified By: Certified for North American Standards
 IP rating: IP43
 IK Rating: IK08
 Glare Rating: ≤ 19

| | |
|-----------|-------|
| PROJECT | _____ |
| TYPE | _____ |
| SPECIFIER | _____ |
| QUANTITY | _____ |
| DATE | _____ |

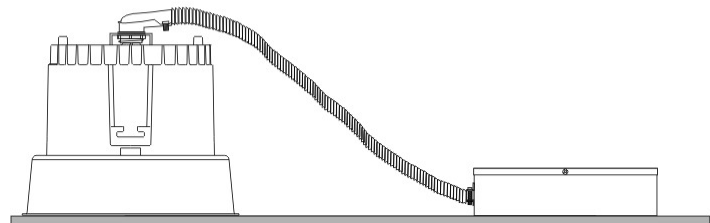
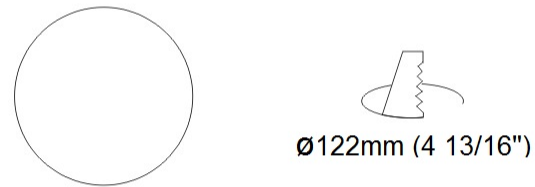
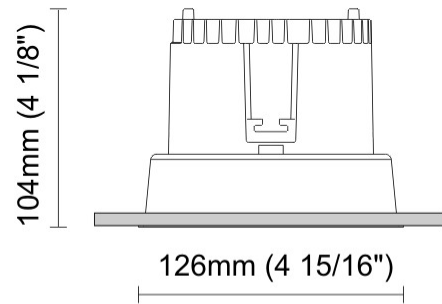

DIXIT RA11 RECESSED

A56028-

| | |
|-----------|--|
| PROJECT | |
| TYPE | |
| SPECIFIER | |
| QUANTITY | |
| DATE | |

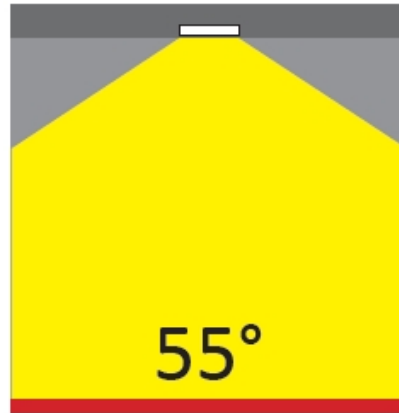
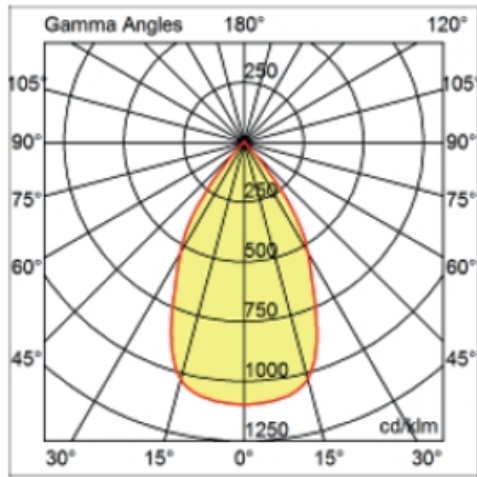

| | | | | | |
|-------------------|-------|-------|-------|-----------------|-------|
| | DP | DV | | Order Example | K° |
| Dimming | Phase | 0-10V | | L5XXXXXX-DV-30K | |
| Color Temperature | 27K | 30K | 35K | 0-10V | 3000K |
| | 2700K | 3000K | 3500K | | |

A

DIXIT RA11 RECESSED

A56032-

base number _____ Color _____
Temperature _____

| | |
|-----------|-------|
| PROJECT | _____ |
| TYPE | _____ |
| SPECIFIER | _____ |
| QUANTITY | _____ |
| DATE | _____ |

- To build a product code in our configurator select the specify button on the base model # product page
- To build a manual product code on this datasheet choose from the options listed below in blue font and add the suffix to the base model #

GENERAL

Series: Dixit
Subseries: Dixit RA11
Brand: Ivela
Division: Architectural
Mounting Type: Recessed
Mounting Location: Ceiling
Subcategory: Downlight

PHYSICAL

Shape: Round
Diameter (mm): 141
Diameter (in): 5 5/16
Height (mm): 117
Height (in): 4 5/8
Min. Recessing Depth (mm): 157
Min. Recessing Depth (in): 6 3/16
Light Distribution: Direct
Weight (kg): 0.7
Weight (lbs): 1.54
Diffuser: Clear Polycarbonate
Fixture Finish: MWH
Fixture Material: Aluminum Die Cast
Cut-out Measurements: 126mm / 4 15/16"

ELECTRICAL

Lamp Type: LED
Total Output Wattage (W): 12 / 18 / 26
Dimming: Tri-Mode (Non-Dimming and Phase Dimming (120Vac only) and 0-10V Dimming)
Driver Included: No
Driver Location: Recessed Housing
Driver Type: Constant Current - Universal
Driver Class: Class 2
Input Voltage (V): 120 - 277
Constant Current (MA): 350 / 500 / 700

LED

Number of LEDs: 1
Color Temperature (°K): 2700 / 3000
Max. Delivered Lumen (lm): 1513 / 2092
CRI: >85 CRI
Efficiency (%): 89
Lamp Life (hrs): 50000
Upon Request: 3500K upon request

OPTICAL

Optic°: 55
Adjustability: Fixed
Upon Request: Optic 12° or 30° (mirror-metallized) / 70° (white)

RATINGS AND CERTIFICATIONS

Certified By: CSA Certified to UL and CSA Standards
IP Rating: IP43
IK Rating: IK08
Glare Rating: ≤ 19

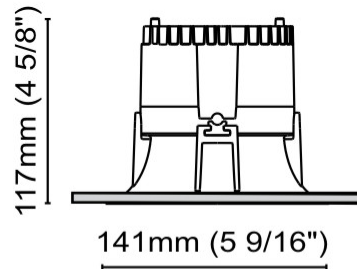

141mm (5 9/16")

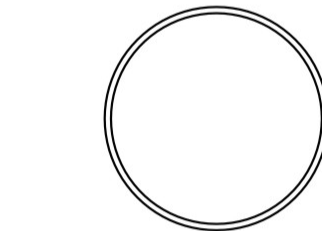

126mm (4 15/16")

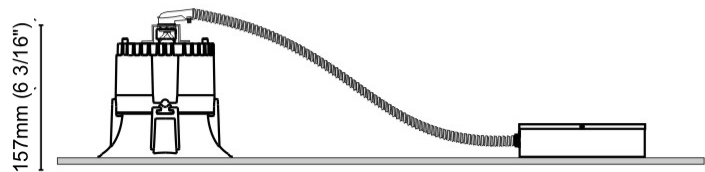

157mm (6 3/16")



DIXIT RA11 RECESSED

A56032-

| | |
|-----------|--|
| PROJECT | |
| TYPE | |
| SPECIFIER | |
| QUANTITY | |
| DATE | |

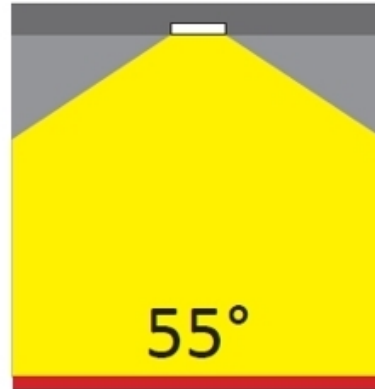

| RA 11 DIXIT LED SOFT 12W 1700 lm 3000K | | | | | R:100% | | I.Max:1293 Cd/Klm | | | |
|--|------|---------|---------|-----------|--------|------|-------------------|---------|----------|--|
| H[m] | D[m] | Max lux | Med lux | Alpha=54° | H[m] | D[m] | Max lux | Med lux | Beta=54° | |
| 1.00 | 1.02 | 1913 | 1003 | | 1.00 | 1.02 | 1913 | 1003 | | |
| 2.00 | 2.04 | 478 | 251 | | 2.00 | 2.04 | 478 | 251 | | |
| 3.00 | 3.06 | 213 | 111 | | 3.00 | 3.06 | 213 | 111 | | |
| 4.00 | 4.08 | 120 | 63 | | 4.00 | 4.08 | 120 | 63 | | |
| 5.00 | 5.10 | 77 | 40 | | 5.00 | 5.10 | 77 | 40 | | |

| | | | | |
|-------------------|-------|-------|-------|----|
| Dimming | DP | DV | | |
| | Phase | 0-10V | | |
| Color Temperature | 27K | 30K | 35K | K° |
| | 2700K | 3000K | 3500K | |

Order Example **K°**

L5XXXXXX-DV-30K

0-10V

3000K



DIXIT RA11 RECESSED

A56051- _____
base number

| | |
|-----------|-------|
| PROJECT | _____ |
| TYPE | _____ |
| SPECIFIER | _____ |
| QUANTITY | _____ |
| DATE | _____ |

- To build a product code in our configurator select the specify button on the base model # product page
- To build a manual product code on this datasheet choose from the options listed below in blue font and add the suffix to the base model #

GENERAL

Series: Dixit
Subseries: Dixit RA11
Brand: Ivela
Division: Architectural
Mounting Type: Recessed
Mounting Location: Ceiling
Subcategory: Downlight

PHYSICAL

Shape: Square
Length (mm): 117
Length (in): 4 5/8
Width (mm): 117
Width (in): 4 5/8
Height (mm): 73
Height (in): 2 7/8
Min. Recessing Depth (mm): 113
Min. Recessing Depth (in): 4 1/2
Light Distribution: Direct
Weight (kg): 0.7
Weight (lbs): 1.54
Diffuser: Clear Polycarbonate
Fixture Finish: MWH
Fixture Material: Aluminum Die Cast
Cut-out Measurements: 100mm / 3 15/16"

ELECTRICAL

Lamp Type: LED
Total Output Wattage (W): 12 / 18 / 26
Dimming: Tri-Mode (Non-Dimming and Phase Dimming (120Vac only) and 0-10V Dimming)
Driver Included: No
Driver Location: Recessed Housing
Driver Type: Constant Current - Universal
Driver Class: Class 2
Input Voltage (V): 120 - 277
Constant Current (MA): 350 / 500 / 700

LED

Number of LEDs: 1
Color Temperature (°K): 2700 / 3000 / 4000
Max. Delivered Lumen (lm): 1513 - 1602 / 2092 - 2180 / 2759 - 2848
CRI: >85 CRI
Efficiency (%): 89
Lamp Life (hrs): 50000
Upon Request: 3500K upon request

OPTICAL

Optic°: 55
Adjustability: Fixed
Upon Request: Optic 12° or 30° (mirror-metallized) / 70° (white)

RATINGS AND CERTIFICATIONS

Certified By: Certified for North American Standards
IP rating: IP43
IK Rating: IK08
Glare Rating: ≤ 19

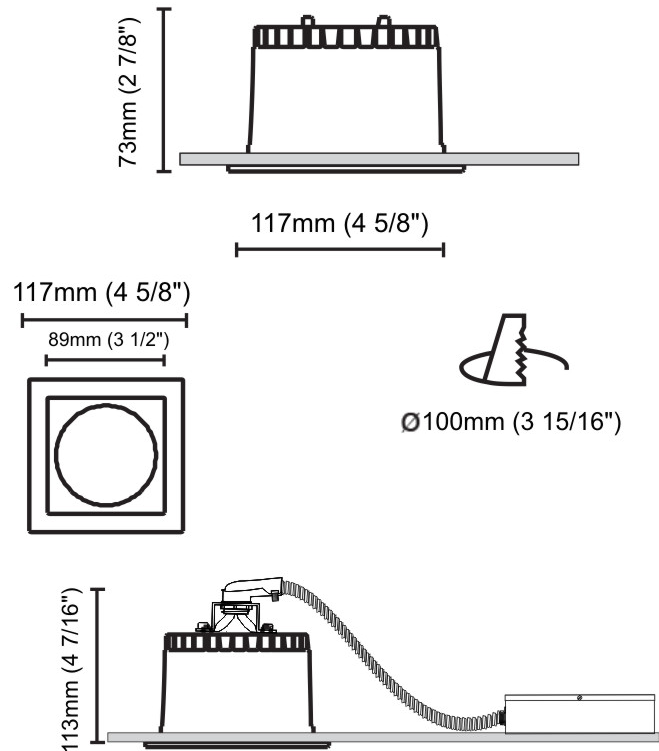

DIXIT RA11 RECESSED

A56051-

| | |
|-----------|--|
| PROJECT | |
| TYPE | |
| SPECIFIER | |
| QUANTITY | |
| DATE | |

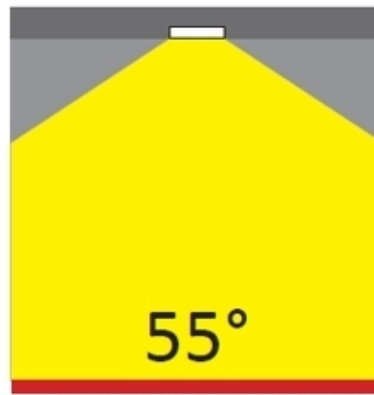
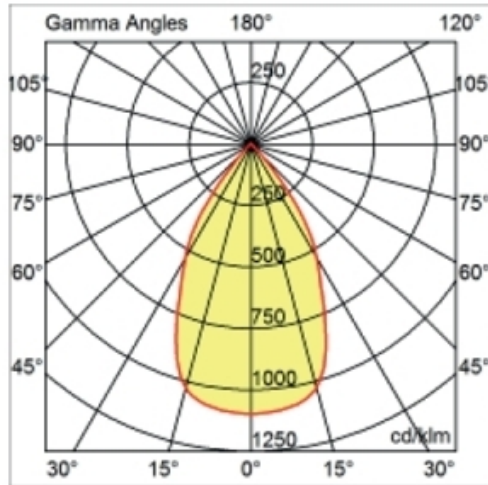

| | | | |
|-------------------|-----------------|-------------------------|---|
| | DP | DV | |
| Dimming | Phase | 0-10V |  |
| Color Temperature | 27K 30K 35K 40K | 2700K 3000K 3500K 4000K | K° |

Order Example  **K°**
L5XXXXXX-DV-30K
 0-10V 3000K



PROJECT

TYPE

SPECIFIER

QUANTITY

DATE

Fixture Finish

Matte White - MWH

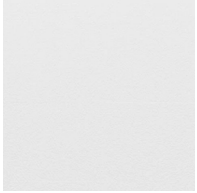

Digital: Not all screens are calibrated the same, and therefore, colors will appear differently between screens.

Physical: When texture is involved, there will be variations in color, character and tone within a product series and between product families.



| | |
|-----------|--|
| PROJECT | |
| TYPE | |
| SPECIFIER | |
| QUANTITY | |
| DATE | |

LEGEND

| | | |
|---|--|--|
| floor-mounted | pivotable | special LED (upon request) RGB, RGBW, tunable, gold+, meat+, art+, fashion+ |
| wall and ceiling: recessed and surface mounted | rotating | warm dim / natural dimming LED |
| ceiling-mounted and wall-mounted | illuminate tilted | rechargeable battery powered |
| wall-mounted | color of suspension cable | fixture with natural vivid LED (upon request) |
| omni-directional light distribution | length of suspension cable | color rendering index |
| direct light distribution | reflector degree selection | color temperature |
| direct/indirect light distribution | super spot | lumen (luminous flux) |
| indirect light distribution | lens | efficacy (lumens per watt) |
| asymmetric light distribution | lens pack | Unified Glare Rating (UGR) range from 5-40 |
| aura light distribution | shine ring | marine grade (AISI 316 stainless steel) |
| round wall or ceiling cut-out | integrated shine ring with diffuser | walk on |
| square wall or ceiling cut-out | free individual colors 01-29 | drive on |
| the supplied jig specifies the cutout dimensions | individual colors: 00 (free of charge), 01-25 (extra charge) | Dark Sky Compliance |
| minimum distance (meters) lamp - object | luminaire part to be colored (F1) | Americans with Disabilities Act (less than 4" off the wall located between 27"-84" from floor) |
| recessed depth | luminaire part to be colored (F2) | lamp protected against explosion |
| ceiling thickness in mm | luminaire part to be colored (F3) | blown glass using traditional methods by master glass blower |
| ceiling thickness selection | luminaire part to be colored (F4) | acoustic material |
| dimmable DP (phase), DV (0-10V), DD (dali), DS (step-dim) | luminaire part to be colored (F5) | protection class I, protection insulation |
| included or excluded LED driver/transformer/control gear | color of 3-circuit adaptor | protection class II, protection insulation |
| separately switchable | indirect diffuser | ETL Certified to UL and CSA Standards |
| sensor | direct diffuser | UL Certified to UL and CSA Standards |
| remote control | ball-proof (upon request) | CSA Certified to UL and CSA Standards |
| available upon request | accessory | Certified for North American Standards |

IP RATING

| | |
|------|--|
| IP20 | protected against ingress of solid bodies greater than 12.5mm (finger) |
| IP33 | protected against ingress of solid bodies greater than 2.5mm protected against sprays of water up to 60 degrees from the vertical (rain) |
| IP40 | protected against ingress of solid bodies greater than 1mm (wire) no protection against the ingress of moisture |
| IP43 | protected against ingress of solid bodies greater than 1mm (wire) protected against sprays of water up to 60 degrees from the vertical (rain) |
| IP44 | protected against ingress of solid bodies greater than 1mm (wire) protected against water splashed from all directions |
| IP54 | protected against limited ingress of dust (wet rooms/covered outdoor areas) protected against water splashed from all directions |
| IP65 | protected against ingress of dust protected against jets of water |
| IP66 | protected against ingress of dust protected against powerful jets of water or heavy seas |
| IP67 | protected against ingress of dust protected against immersion of water between 15cm - 1m for 30 minutes |
| IP68 | protected against ingress of dust protected against immersion of water under pressure for long periods |

IK RATING

| | |
|------|---|
| IK01 | protected against 0.14 joules impact (equivalent to 0.25kg mass dropped from 56mm above the surface) |
| IK02 | protected against 0.2 joules impact (equivalent to 0.25kg mass dropped from 80mm above the surface) |
| IK03 | protected against 0.35 joules impact (equivalent to 0.25kg mass dropped from 140mm above the surface) |
| IK04 | protected against 0.5 joules impact (equivalent to 0.25kg mass dropped from 200mm above the surface) |
| IK05 | protected against 0.7 joules impact (equivalent to 0.25kg mass dropped from 280mm above the surface) |
| IK06 | protected against 1 joules impact (equivalent to 0.25kg mass dropped from 400mm above the surface) |
| IK07 | protected against 2 joules impact (equivalent to 0.5kg mass dropped from 400mm above the surface) |
| IK08 | protected against 5 joules impact (equivalent to 1.7kg mass dropped from 300mm above the surface) |
| IK09 | protected against 10 joules impact (equivalent to 5.0kg mass dropped from 200mm above the surface) |
| IK10 | protected against 20 joules impact (equivalent to 5.0kg mass dropped from 400mm above the surface) |